

Chain guides and accessories

Part. **444**

Chain inlet guide shoe
(side)

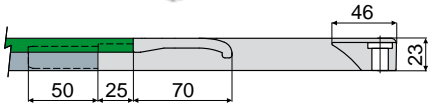

Right Version

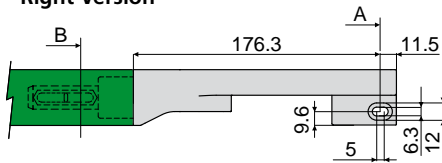

Left Version

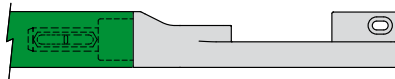

Section B

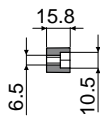

Section A

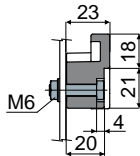

For stainless steel profiles	
Version	Code
Right	444 / 85308
Left	444 / 85309

For aluminium profiles	
Version	Code
Right	444 / 88953
Left	444 / 89037

NEW
NEW

MATERIALS: Shoe in black polyamide.

FEATURES: To be assembled near to the idler wheels to drive the chain on the transport guides: Part.381, 384, 513.

BOX QUANTITY: 24 pieces.

ON REQUEST:

- Shoes: In various colours.
- Box quantity: According to your request.

Part. **389**

Chain inlet guide shoe
(central)

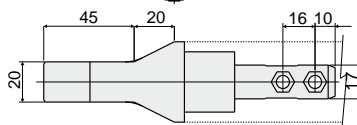
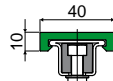
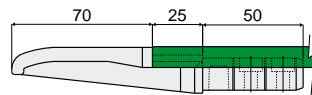

For stainless steel profiles	
Code	
389 / 84165	

For aluminium profiles	
Code	
389 / 89049	

NEW

MATERIALS: Shoe in black polyamide.

FEATURES: To be assembled near to the idler wheels to drive the chain on the transport guides: Part.381, 384, 513.

BOX QUANTITY: 24 pieces.

ON REQUEST:

- Shoes: In various colours.
- Box quantity: According to your request.

Example of application

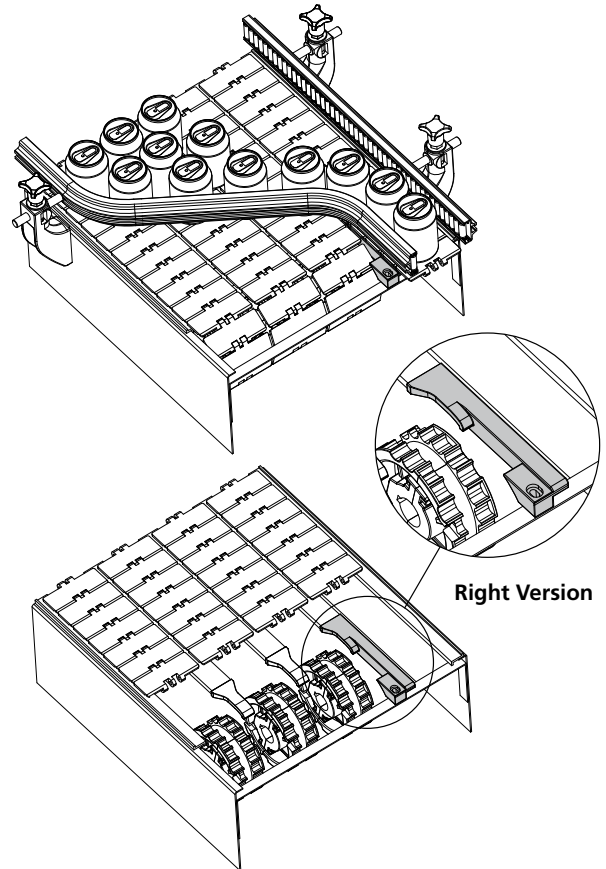

Right Version

Example of application

